

VT6CSH W * - 022 - 1 R 00 - B 1 - 00 *

Series

Use for severe duty shaft only

One letter can be added to specify special parts in series

Cam ring

Volumetric displacement cm^3/rev (in^3/rev)

*003/B03/Y03 = 10.8 (0.66)	015/B15/Y15 = 50.5 (3.08)
005/B05/Y05 = 17.2 (1.05)	017/B17/Y17 = 58.3 (3.56)
006/B06/Y06 = 21.3 (1.30)	020/B20/Y20 = 63.8 (3.89)
008/B08/Y08 = 26.4 (1.61)	022/B22/Y22 = 70.3 (4.29)
010/B10/Y10 = 34.1 (2.08)	025/B25/Y25 = 79.3 (4.84)
012/B12/Y12 = 37.1 (2.26)	028/B28/Y28 = 88.8 (5.42)
014/B14/Y14 = 46.0 (2.81)	031/B31/Y31 = 100.0 (6.10)

* '0' - Uni - directional 'B' - Bi - directional 'Y' - Bi - directional for cold start

Type of shaft

- 1 - Keyed (SAE B)
- 3 - Splined (SAE B)
- 4 - Splined (SAE BB)

Severe duty shaft VT6CSHW

- 5 - Keyed (SAE BB)

Modifications

Mounting W/connection variables

	UNC		METRIC	
	00	01	M0	M1
P	1"	3/4"	1"	3/4"
S	1 1/2"			

Seal class

- 1 - S1 (for mineral oil)
- 4 - S4 (for fire resistant fluids)
- 5 - S5 (for mineral oil and fire resistant fluids)

Design letter

Porting combination

00 - standard

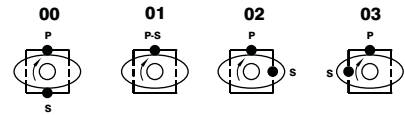

S - Suction port P - Pressure port

Direction of rotation (view on shaft end)

- R - clockwise
- L - counter-clockwise

VP
SP

INTERNAL LEAKAGE (TYPICAL)

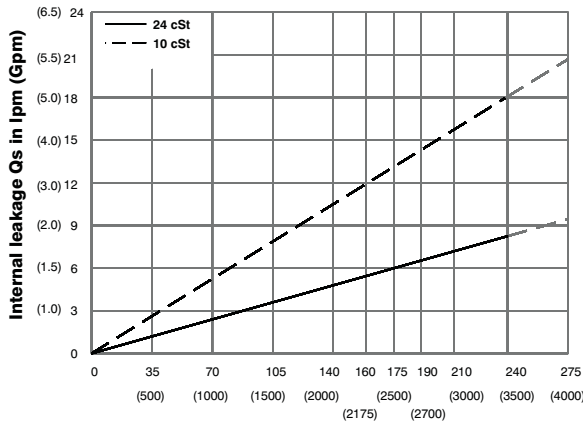

Pressure in bar (psi)

Do not operate pump more than 5 seconds at any speed or viscosity if internal leakage is more than 50% of theoretical flow.

NOISE LEVEL (TYPICAL)

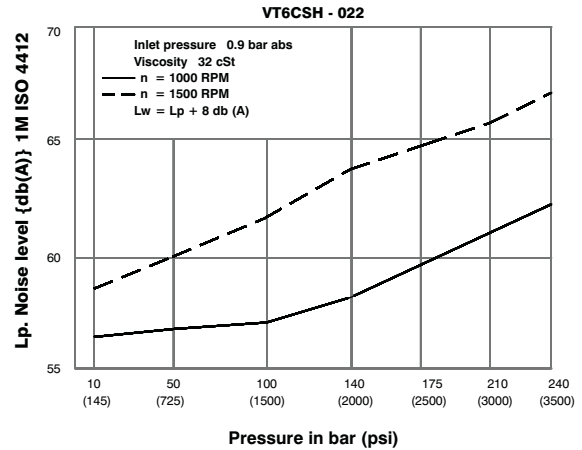

Pressure in bar (psi)

HYDROMECHANICAL POWER LOSS (TYPICAL)

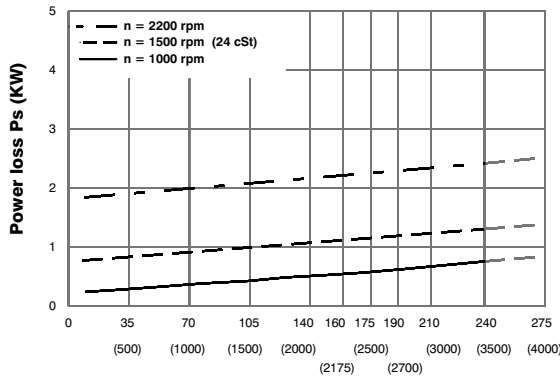

Pressure in bar (psi)

PERMISSIBLE RADIAL LOAD

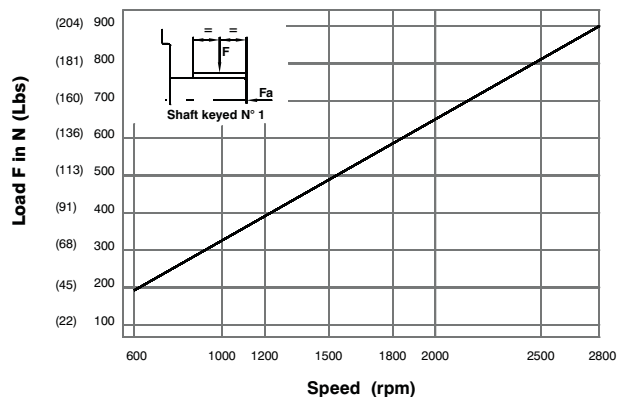

Maximum axial load permissible $F_a = 800 \text{ N}$ (180 Lbs)

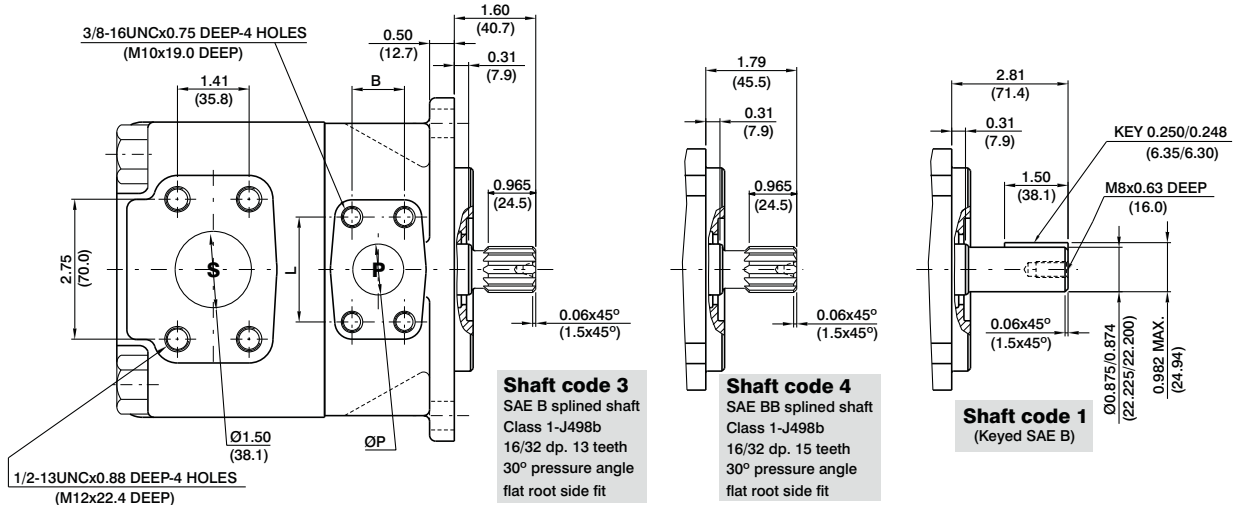

VP
SP

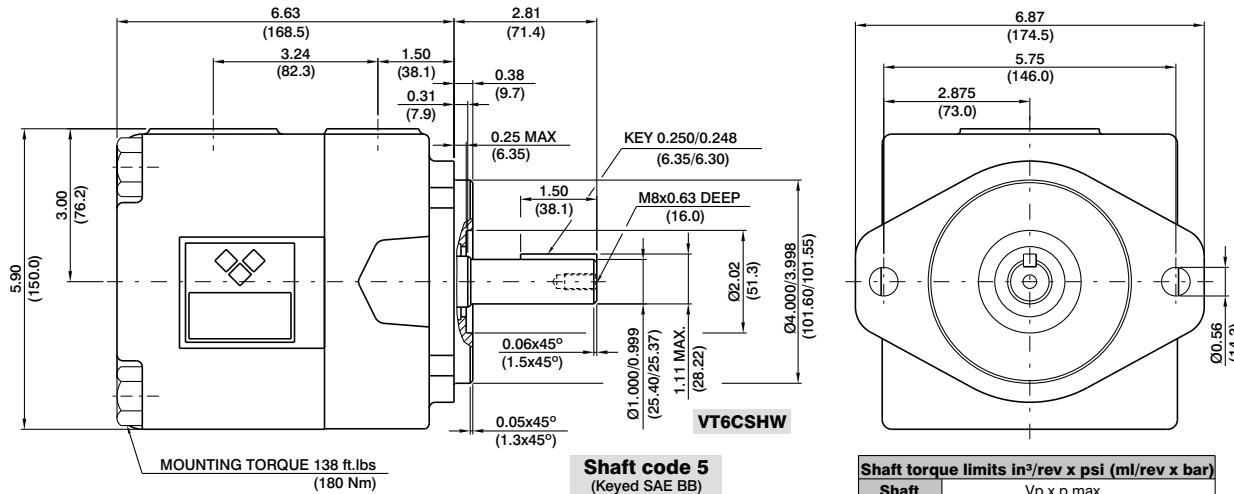

ØP	L	B
0.75 (19.05)	1.87 (47.6)	0.87 (22.2)
1.00 (25.4)	2.06 (52.4)	1.03 (26.2)

Shaft	Vp x p max.
1	14473 (16500)
3	18246 (20600)
4	19309 (21821)
5	18945 (21420)

OPERATING CHARACTERISTICS - TYPICAL (24 cSt)

Pressure port	Series	Volumetric Displacement Vp		Flow q & n = 1500 rpm						Input power p & n = 1500 rpm					
				p = 0 bar (0 psi)		p = 140 bar (2000 psi)		p = 240 bar (3500 psi)		p = 7 bar (100 psi)		p = 140 bar (2000 psi)		p = 240 bar (3500 psi)	
		in ³ /rev	cm ³ /rev	gpm	lpm	gpm	lpm	gpm	lpm	hp	kw	hp	kw	hp	kw
VT6CSH	003	0.66	10.8	4.29	16.2	2.96	11.2	2.04	7.7	1.74	1.3	7.11	5.3	11.26	8.4
	005	1.05	17.2	6.83	25.8	5.50	20.8	4.57	17.3	1.88	1.4	10.06	7.5	16.36	12.2
	006	1.30	21.3	8.44	31.9	7.11	26.9	6.19	23.4	2.01	1.5	11.94	8.9	19.71	14.7
	008	1.61	26.4	10.48	39.6	9.15	34.6	8.22	31.1	2.15	1.6	14.35	10.7	22.93	17.7
	010	2.08	34.1	13.52	51.1	12.19	46.1	11.26	42.6	2.28	1.7	18.64	13.4	29.90	22.3
	012	2.26	37.1	14.71	55.6	13.36	50.6	12.46	47.1	2.28	1.7	19.31	14.4	32.32	24.1
	014	2.81	46.0	18.25	69.0	16.93	64.0	16.00	60.5	2.55	1.9	23.60	17.6	39.56	29.5
	015	3.08	50.5	20.00	75.6	18.73	73.2	19.02	67.5	2.68	2.0	25.61	19.1	42.91	32.0
	017	3.56	58.3	23.12	87.4	21.79	82.4	20.87	78.9	2.82	2.1	29.37	21.9	49.48	36.9
	020	3.89	63.8	25.32	95.7	23.99	90.7	23.07	87.2	2.95	2.2	31.92	23.8	53.91	40.2
	022	4.29	70.3	27.88	105.4	26.56	100.4	25.63	96.9	3.08	2.3	35.00	26.1	59.14	44.1
	025 ¹⁾	4.84	79.3	31.46	118.9	30.13	113.9	29.21	110.4	3.35	2.5	39.16	29.2	66.38	49.5
	028 ^{1,2)}	5.42	88.8	35.24	133.2	33.92	128.2	33.28	125.8	3.75	2.8	43.85	32.7	65.04	48.5
031 ^{1,2)}	6.10	100.0	39.68	150.0	38.35	145.0	37.72	142.6	3.75	2.8	48.95	36.5	72.95	54.4	

1) 025-028-031 = 2500 RPM. max.

2) 028-031 = 210 bar (3000 psi) max. int.