

VM3B - 1 - 036 - 1 N 00 - B 1 01 *

Series

Internal Drain
(Omit for External Drain)

Torque

- 009 = 0.130 Nm/bar
- 012 = 0.186 Nm/bar
- 018 = 0.304 Nm/bar
- 027 = 0.485 Nm/bar
- 036 = 0.624 Nm/bar

Type of shaft

- 1 - keyed (no SAE)
- 3 - splined (SAE A)
- 4 - splined (SAE B)

Rotation

N - bi-directional

View from shaft end:

- CW rotation A = inlet
B = outlet
- CCW rotation A = outlet
B = inlet

Modifications

Port connections

- 00 = SAE threaded port
SAE drain
- 01 = SAE 4 bolt flange
BSPP drain
- 02 = BSPP threaded port
BSPP drain

Seal class

- 1 - S1
- 4 - S4
- 5 - S5

Design letter

Porting combination

00 - standard

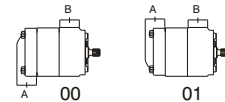

VM

INTERNAL LEAKAGE

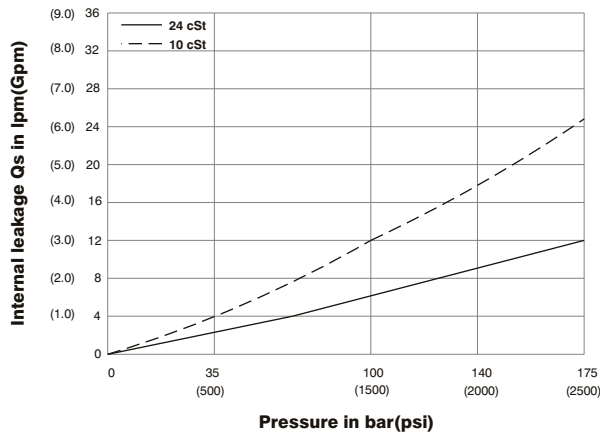

PERMISSIBLE RADIAL AND AXIAL LOADS

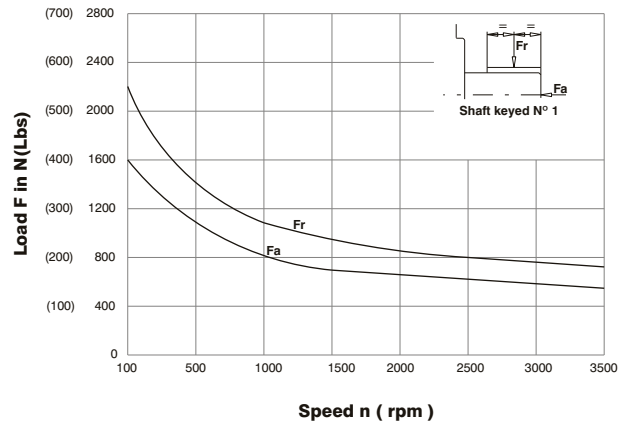

Do not apply Fr and Fa loads simultaneously

OPERATING CHARACTERISTICS - TYPICAL (24 cSt)

Model	Series	Volumetric Displacement Vi		Input flow at n = 2000 rpm				Torque T at n = 2000 rpm		Power output at n = 2000 rpm	
				Theoretical		at 175 bar (2500 psi) Δp		at 175 bar (2500 psi) Δp		at 175 bar (2500 psi) Δp	
		in ³ /rev	cm ³ /rev	GPM	l/min	GPM	l/min	lbf.in	Nm	HP	KW
VM3B	009	0.56	9.2	4.9	18.4	8.0	30.4	174.3	19.7	5.8	4.3
	012	0.75	12.3	6.5	24.6	9.7	36.6	236.3	26.7	7.8	5.8
	018	1.13	18.5	9.8	37.0	12.9	49.0	412.4	46.6	13.4	10.0
	027	1.70	27.8	14.7	55.6	17.8	67.6	680.5	77.4	21.8	16.3
	036	2.26	37.1	19.6	74.2	22.8	86.2	902.6	102.0	28.3	21.1

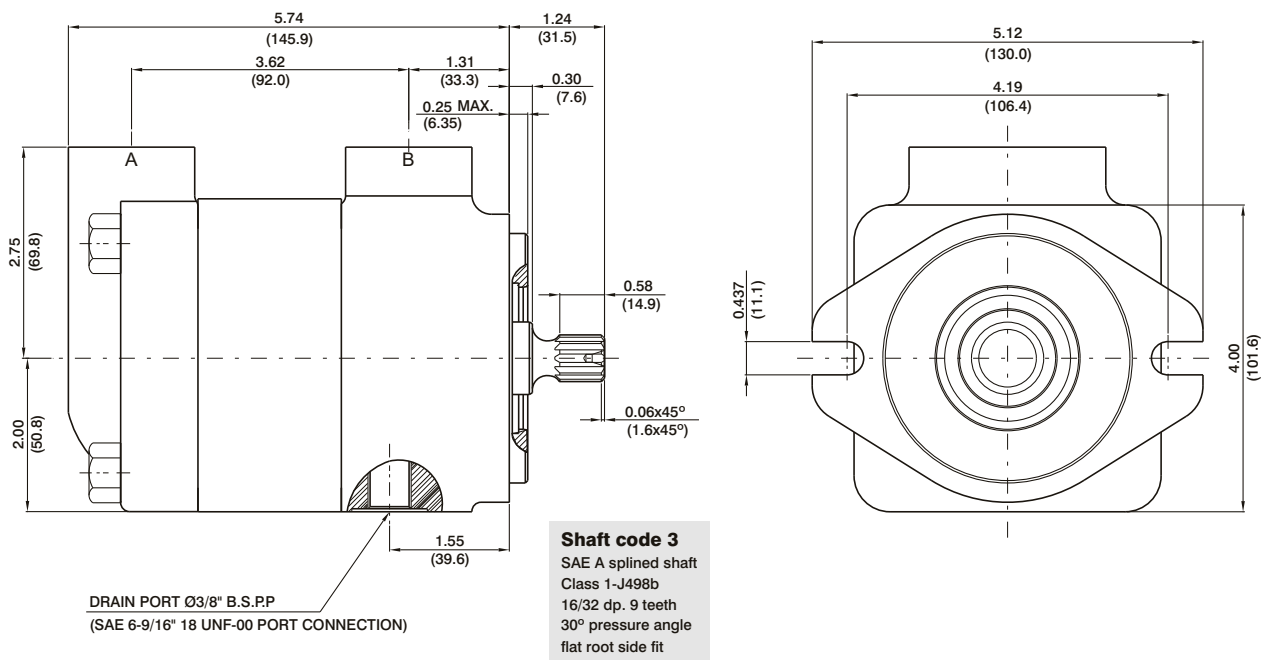
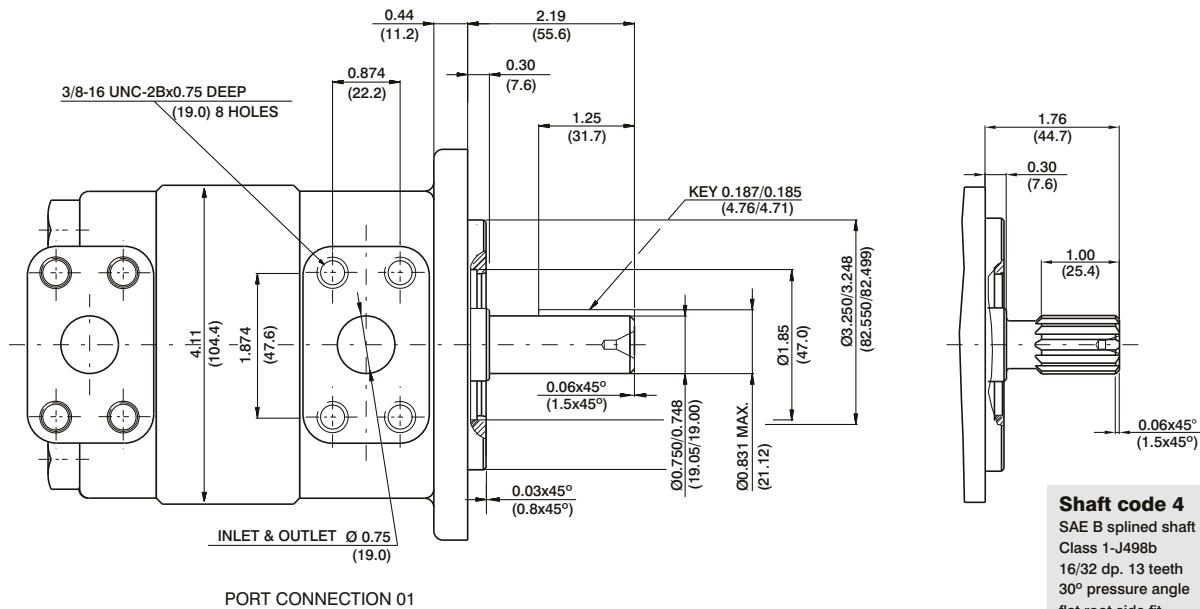

SAE 12(1 1/16"-12 UNF)

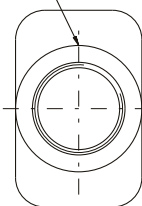

PORT CONNECTION 00

3/4 BSPP-0.75 DEEP
(19.0)

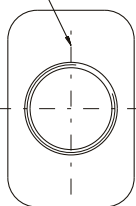

PORT CONNECTION 02